



# Hydrocarbon Processing Industry Gas Chromatographs

- Standard GC Analyzer Solutions



Scion Instruments' GC Analyzer specialists have the knowledge and experience to provide pre-configured gas chromatographic systems for hydrocarbon processing applications that are ready, at power up, to handle key applications. Our extensive experience with designing, manufacturing, testing and commissioning complex hydrocarbon analyzers ensures that you get the solution that's right for you. With a wide selection of standard analyzers configured to meet the performance requirements of industry standard methods, Scion Instruments has the answers that you seek.

## Scion Analyzer Solutions

### Benefits

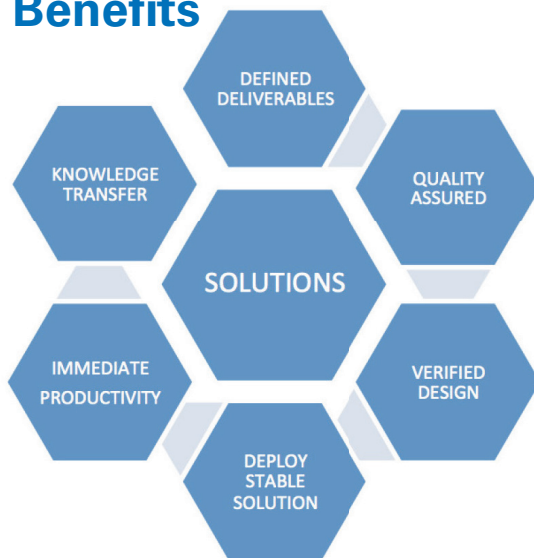

Scion configures and tests GC hardware and software according to widely used industry standard methods (e.g. ASTM, UOP, EN, ISO, GPA,...), to save its clients time and to ensure confidence in results. Solutions are configured to meet the performance specifications outlined in the standard method itself.

### Included with all Scion Analyzer solutions:

- All Hardware
- Software (incl. special "plug-ins" where appropriate)
- Pre-Installed methods
- Test Chromatograms
- Installation/Validation Data
- Trouble Shooting Guide
- User documentation customized for the specific method

# Scion Simulated Distillation Analyzers

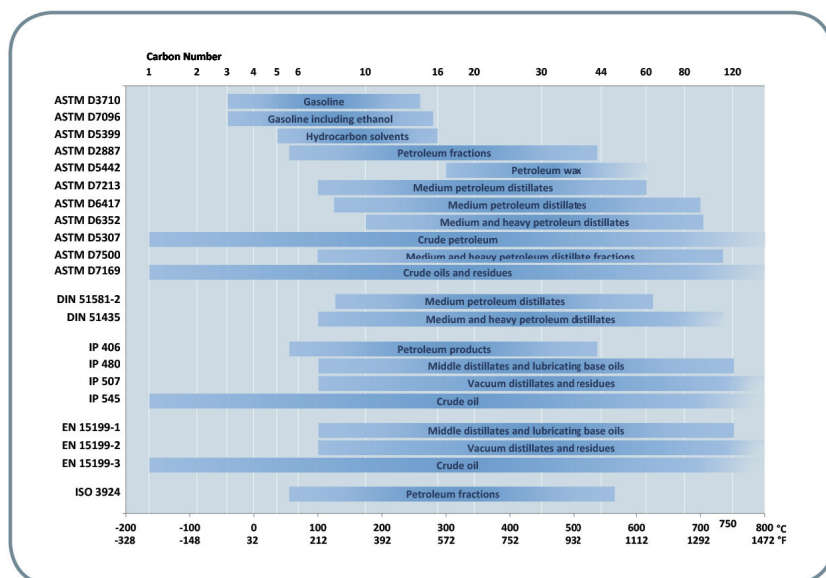

**Table 1:** Overview Simdist methods.

Simulated Distillation (SimDist) reproduces the physical distillation of petroleum products by determining boiling point distribution using a GC. Scion Instruments' range of Simulated Distillation Analyzers combined with the CompassCDS and SimDist software provide you with completely integrated systems designed to meet the exacting requirements of industry standard SimDist methods that include the D86 and D1160 correlation.



Scion 436 SimDist Analyzer

## Key Benefits Include:

- Accurate boiling point distribution up to 750°C
- Integrated standard test methods, applications fully comply with ASTM, IP, DIN and ISO standard test methods
- Complete, single vendor solution
- Complete control from initial setup to final report
- ASTM D86 and ASTM D1160 correlation

## Built-in Reports:

Scion's SimDist software provides a wide variety of report options to meet specific requirements including;

- Chromatogram with merged corrected blank analysis and IBP/FBP marks versus retention time
- Boiling point versus percentage
- Table and plot with retention time versus boiling point
- ASTM D86 and D1160 Correlations
- DIN Noak and motor oil volatility reports
- Table with cut points and fractions plus residue analysis with recovery calculation up to C120

# Detailed Hydrocarbon Analyzer

The SCION DHA Analyzer is a complete high resolution GC solution for the analysis of hydrocarbons in petroleum streams capable of performing all of the standard methods including ASTM D6729, D6730, D6733, D5134, D6623, IP 344/DHA "Front End" and "Fast DHA."

Although each DHA analyzer is configured, tested and certified at the factory for a standard method specified by the customer, the DHA software also permits operators to produce reports using any of the other standard methods. And, because of the outstanding performance and flexibility of the Scion GC and CompassCDS software, users are able to quickly modify existing methods or add new ones when required.

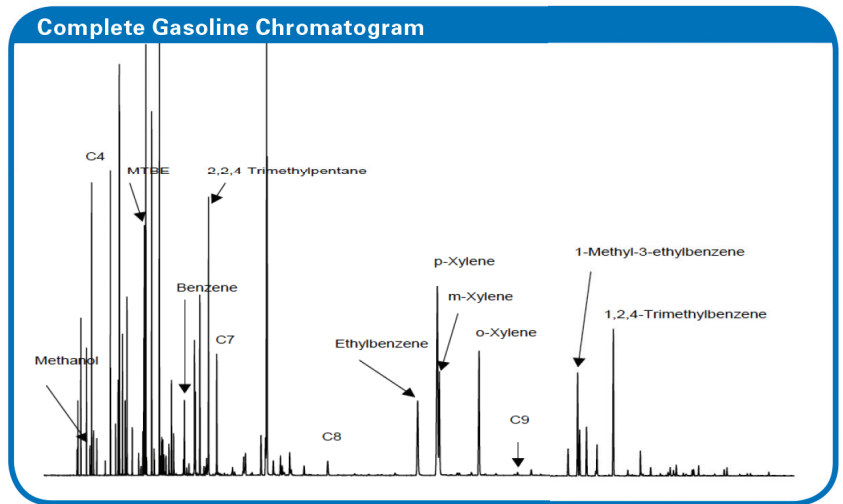

Figure 1. The analysis of hydrocarbons using the Scion DHA

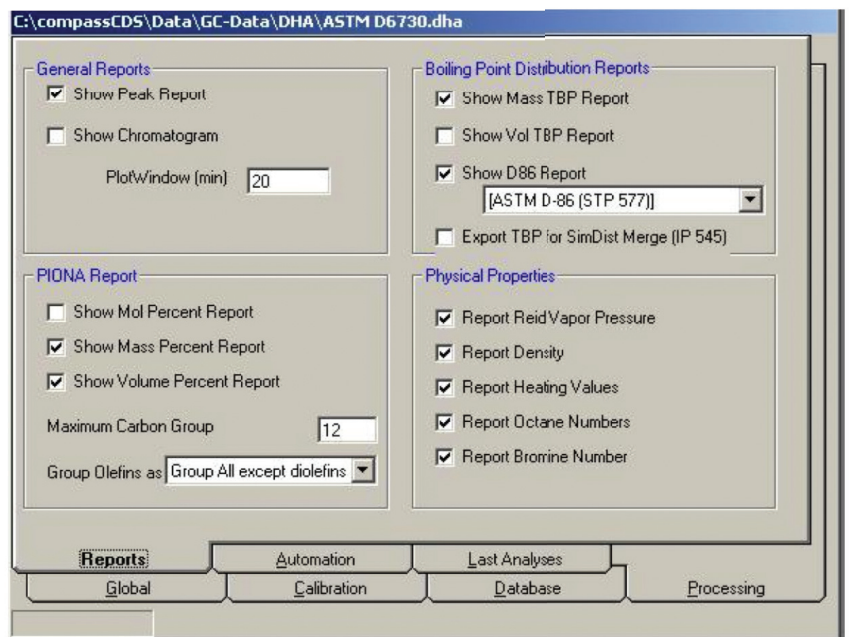
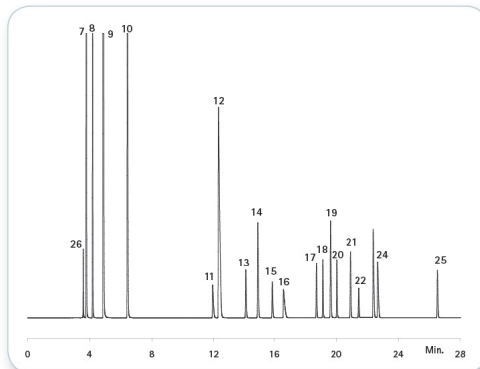

Figure 2. DHA report output selection

# Scion Refinery Gas Analyzers

## Peak Identification

1. Hydrogen
2. Carbon Dioxide
3. Hydrogen Sulfide
4. Oxygen
5. Nitrogen
6. Carbon Monoxide
7. Methane
8. Ethane
9. Ethylene
10. Propane
11. Cyclo Propane
12. Propylene
13. i-Butane
14. n-Butane
15. Propadiene
16. Acetylene
17. t-2-Butene
18. i-Butene
19. c-2-Butene
20. i-Pentane
21. n-Pentane
22. 1, 3-Butadiene
23. Propyne
24. Butyne
25. C6+
26. Helium

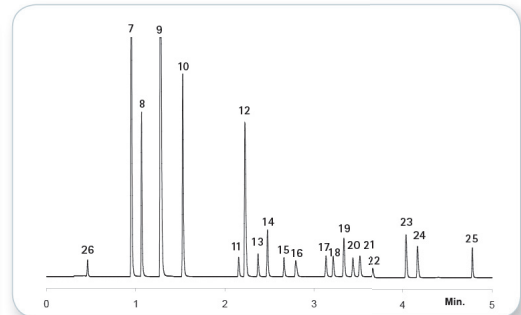

**Figure 3:** The separation of light hydrocarbons using the Standard RGA.

Scion's Refinery Gas Analyzers (RGA) are designed to deliver superior, reliable results for a wide range of sample types.

### Key Benefits:

- Pre-configured and tuned
- Standard methods including UOP 539, DIN-51666 and ASTM D2163
- Integrated micro-gasifier ensures complete vaporization of LPGs and high pressure samples to prevent sample discrimination (option)
- Multi-channel approach



**Figure 4:** The analysis of light hydrocarbons using the Rapid RGA, with complete separation in less than five minutes.

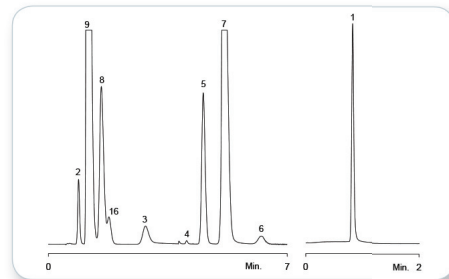

**Figure 5:** The analysis of permanent gases and hydrogen using the Rapid RGA.

**Scion offers two types of RGA systems to accommodate the broadest range of analyses.**

### Standard RGA:

A three channel multi-valve design using both capillary and packed columns.

Channel 1 - Analysis of permanent gases

Channel 2 - Light hydrocarbons

Channel 3 - Hydrogen

Total analysis time for all components in 25 minutes.

### Rapid RGA:

The Standard RGA packed columns in the hydrogen and permanent gas channels are replaced by micro packed columns and installed in a separate column oven. Key benefits of this design include:

- Flexibility
- Reduced Analysis Time - 5mins (with H<sub>2</sub>S - 7mins)
- Increased Sample Throughput

Characteristics	Standard RGA	Rapid RGA
No. of Channels/Detectors Used	3	3
No. of Column Ovens	1	2
Analysis Time	25 min	5 min (7 min with H <sub>2</sub> S)
Repeatability	<1%	<1%
Linear Bench Space Required	66 cm/26 in.	66 cm/26 in.
Minimum Component Detection Level	0.01% all components except H <sub>2</sub> S = 0.05%	0.01% all components except H <sub>2</sub> S = 0.05%
<b>Suitability</b>		
Typical Refinery Gas	Excellent	Excellent
Impurities in Bulk Ethylene	Excellent	Excellent
Impurities in Bulk Propylene	Excellent	Good
Impurities in Bulk C4	Good	Good

**Table 2:** Standard RGA vs Rapid RGA.

# Natural Gas Analyzers

Natural gas is bought and sold as a bulk commodity with price based on its energy content. It is essential for all stakeholders in the supply chain to be able to accurately determine the heating value of natural gas streams. Scion Instruments provides a complete range of GC based solutions for the analysis of natural gas. The Scion "NatGas" analyzer family is designed to offer superior results through the use of industry proven hardware, software, optimized columns and consumables, and is backed by a team of global sales and support specialists.

## Key Benefits include:

- A complete selection of natural gas analysis (NGA) solutions designed to meet the broadest range of sample stream types and throughput requirements, whether the analysis is conducted in a laboratory, at-line or in the field.
- Flexibility to analyze natural gas, liquified petroleum gas or natural gas liquids (NGL). Scion's GC based NGA analyzers can be configured to measure the composition of LPG or NGL streams through the use of specialized sample conditioners, ensuring sample integrity is consistently maintained.
- The SCION GC, CompassCDS Chromatography Software and the Natural Gas Reporting Tool, combine to create a powerful and yet easy to use natural gas analysis system that covers GPA/ISO/ASTM methods.
- Operational procedures are fully documented. All Scion NGA analyzers incorporate proven GC hardware and software, and come pre-loaded analysis method(s) and application specific documentation.



The SCION GC based Natural Gas Analyzer

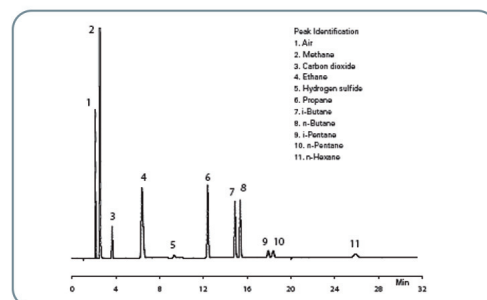

Figure 6: Typical Natural Gas separation

## Natural Gas Analyzer Type "A"

This system, designed for simplicity, uses a single valve & column, a Thermal Conductivity Detector (TCD) and Flame Ionization Detector (FID) plumbed in series. The TCD detects and quantifies O<sub>2</sub>, N<sub>2</sub>, CO<sub>2</sub> methane and ethane while the FID determines higher hydrocarbons, i.e., C3-C5 and the C6+ back-flushed grouping peak (late back-flush). A single unheated 4 port Liquid Sampling Valve (LSV) is available for LPG type samples.

## Natural Gas Analyzer Type "B"

Optimized for the analysis of natural gas or de-methanized hydrocarbon matrices, the components of interest are typically O<sub>2</sub>, N<sub>2</sub>, CO<sub>2</sub>, methane, ethane, propane, butane, isobutane, pentane, H<sub>2</sub>S, and C6+ as a composite peak. De-methanized streams (liquid natural gas) typically CO<sub>2</sub>, ethane, propane, butane, iso-pentane, hexane, and C7+ as a composite peak. The system is configured with a 10 and 12 port valve and three columns connected to TCD and FID detectors. The sample stream is simultaneously injected onto two column systems, a Molsieve column for the determination of O<sub>2</sub> and N<sub>2</sub> and short/ long Non-Polar columns for the analysis of hydrocarbons and CO<sub>2</sub>. The Non-Polar columns are set up for early back-flush, which optimizes sensitivity while reducing run time. The "B" System has two standard options, a 4 port LSV for the analysis of de-methanized liquefied natural gas distillates (i.e. propane, butanes and pentanes) and an extra GC detector channel for the analysis of H<sub>2</sub> and He in natural gas.

## Natural Gas Liquids Analyzer - Extended Type "C"

Specifically designed to analyze 'rich' natural gas or natural gas liquid streams, this system separates and quantifies all hydrocarbon components up to C16. As with the Type B analyzer, O<sub>2</sub> and N<sub>2</sub> are separated and quantified and H<sub>2</sub>S is measured down to ~100 ppm. The system has a 14 port valve that enables the sample stream to be simultaneously introduced into three separate columns which two of the sample paths flow onto Molsieve and porous polymer columns to separate O<sub>2</sub>, N<sub>2</sub> CO<sub>2</sub>, ethane, methane, ethane and H<sub>2</sub>S, and the other via a 'splitter' onto a high performance nonpolar capillary column to separate hydrocarbons up through C16. The 6 port valve is used to direct the separated components fraction to the TCD while components remaining on the Molsieve column are flushed to vent. For analysis of natural gas liquids a third valve (liquid sampling) is added and for natural gas containing hydrogen and helium a He/H<sub>2</sub> channel is added to the configuration.

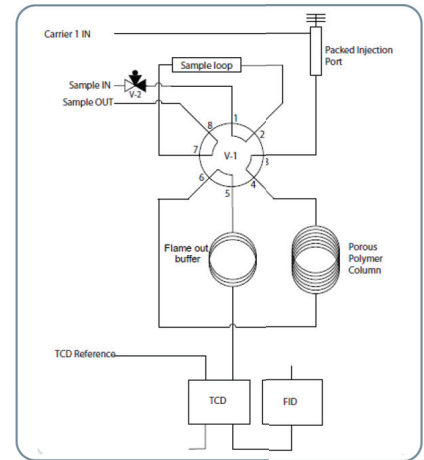

Figure 7a: Scion type "A" NGA

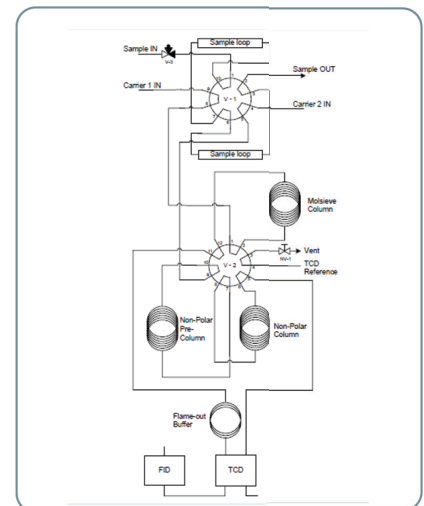

Figure 7b: Scion type "B" NGA

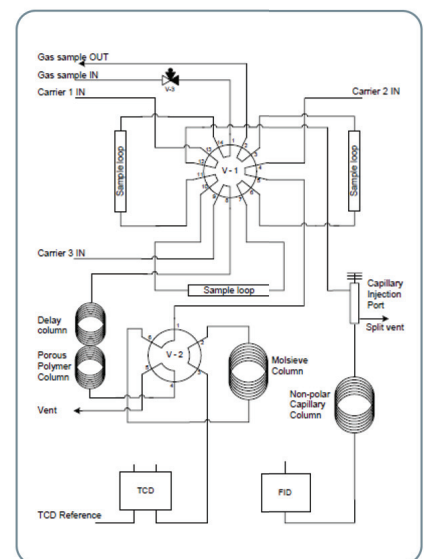
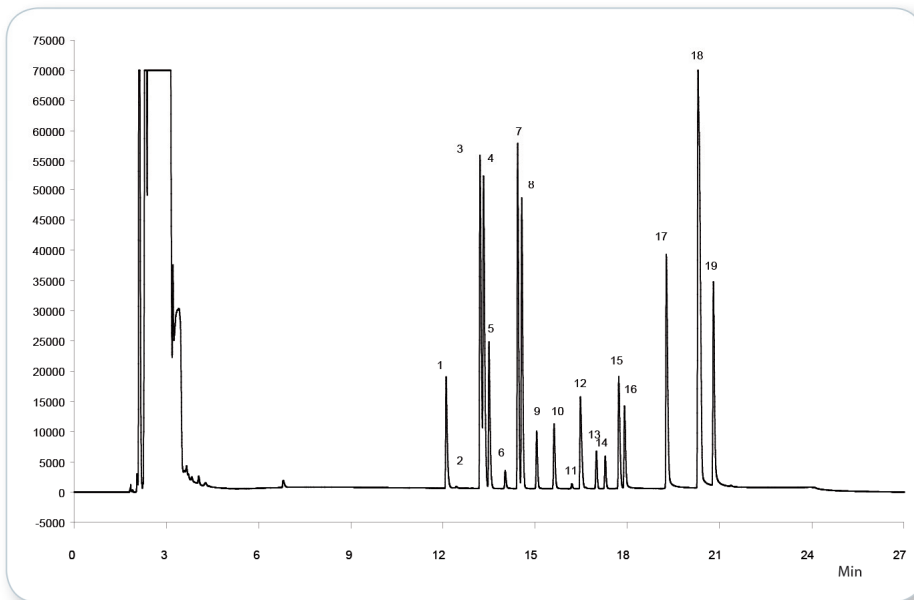

Figure 7c: Scion type "C" NGA

# Low Level Oxygenates Analyzer



**Figure 8:** Typical chromatogram showing a wide range analysis of a liquid sample stream.

The analysis of sub-ppm levels of ethers (e.g., DME, MTBE, ETBE, DIPE) alcohols, aldehydes and ketones in different hydrocarbon matrices is a recurring challenge for hydrocarbon processing analytical laboratories. Scion's Low Level Oxygenate Analyzer is an easy to use solution that meets this challenge according to ASTM D7423.

The system is comprised of a Scion GC configured with gas and liquid sampling valves, two high performance capillary columns, digitally controlled pneumatics that includes a 'fluidic' switch and a Flame Ionization Detector (FID). An optional pressure station can be added to eliminate sample loss due to evaporation when analyzing LPG. This Analyzer is controlled by the CompassCDS software.

## Peak Identification

1. Diethylether
2. Acetaldehyde
3. Ethyl tert. Butyl ether
4. Methyl tert. Butyl ether
5. Diisopropylether
6. Propanal
7. tert amyl methyl ether
8. Propylether
9. Isobutyraldehyde
10. Butyraldehyde
11. Methanol
12. Acetone
13. Isovaleraldehyde
14. Valeraldehyde
15. 2-Butanone
16. Ethanol
17. 1-Propanol
18. tert Butyl alcohol & Isobutanol
19. 1-Butanol



# Scion 4815 GC Oxygenates Analyzer

The Scion 4815 GC Analyzer provides a highly cost effective solution for the analysis of oxygenates in gasoline, according to the widely used industry standard method ASTM D4815. The combination of Scion's reliable GC hardware, powerful software and industry leading pre- and post-sales support teams make this analyzer package the most comprehensive solution available today.

Oxygenated compounds can be present in various hydrocarbon matrices either because these were purposely added (e.g., into gasoline), because these are naturally present, or formed during catalytic processes such as polymer production. In gasoline, oxygenated compounds are added as 'anti-knock' agents to increase the octane number and decrease emissions by replacing organo-lead compounds.

The type and concentration of oxygenated compounds must be measured in reformulated gasolines as part of ongoing product quality assessment, and to confirm the oxygenated components have been added in the correct amounts according to regulatory requirements (e.g., California Air Resources Board).

ASTM D4815 is frequently chosen as the standard method for the determination of oxygenated compounds. Individual ethers and alcohols are quantified in gasoline including: MTBE, ETBE, TAME, DIPE, C1-C4 alcohols and tert-amylalcohol. Individual ether components are measured from 0.1 to 20.0 mass %. The individual alcohols are measured from 0.1 to 12.0 mass %.



456-GC with Sampler

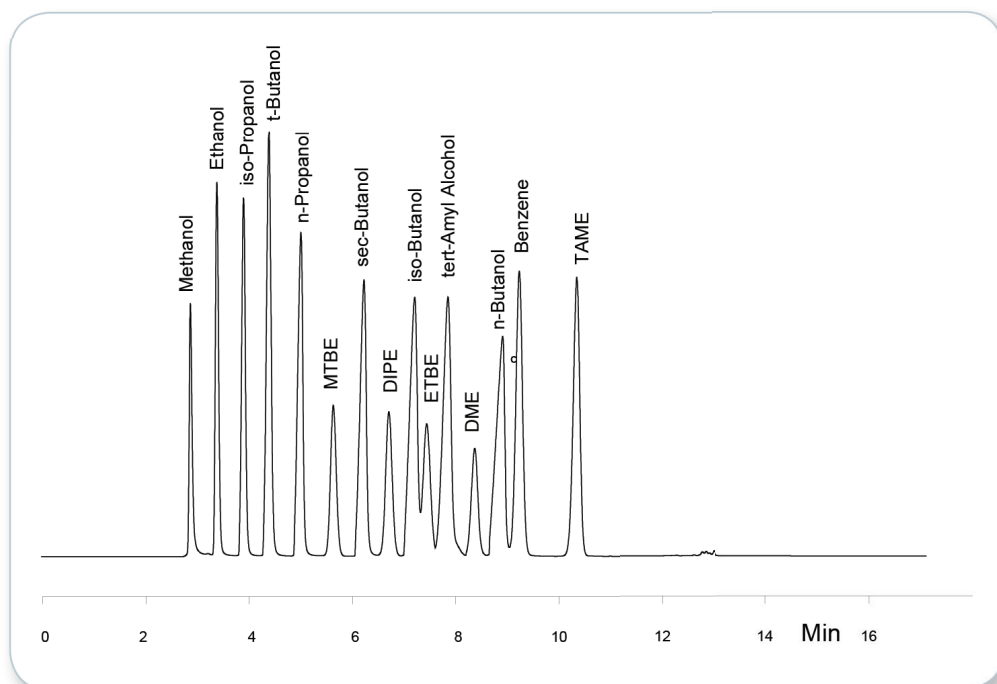

Figure 9. Oxygenate test standard separation

# Trace Impurity Analyzers

## Sulfur Components in LPGs

Low level analysis of sulfur containing components such as  $H_2S$ , COS and mercaptans is extremely challenging and Scion has a GC solution specifically configured for this type of trace impurity analysis. This system employs a micro-gasifier that enables the direct coupling of an LPG stream. An inert stainless steel flow path ensures trouble free analysis of sulfur containing samples and a two channel PFPD/two column approach permits the analysis of all components of interest in one run irrespective of the LPG matrix. Using two differing columns ensures that quenching of the PFPD signal by the matrix is overcome and complete sulfur species analysis is achieved. Figures 10a & 10b show chromatograms obtained from a propane matrix and illustrate the benefits of the novel 2 channel approach.

## Permanent Gases in LPGs

Impurities such as  $CO$ ,  $CO_2$ ,  $H_2$ ,  $O_2$  and  $N_2$  also need to be determined at low levels in LPGs. Complete separation of these components is done using a two channel single detector (PDHID) system. The GC employs a permanent gas channel for analyzing  $H_2$ ,  $O_2$ ,  $N_2$ ,  $CH_4$  and  $CO$  and a specific second channel for the analysis of  $CO_2$ . A gasifier is used as a sample introduction device thus giving the capability of handling LPG samples  $C_2$  through  $C_4$ .

Detection limits are at the ppm level depending on the component of interest.

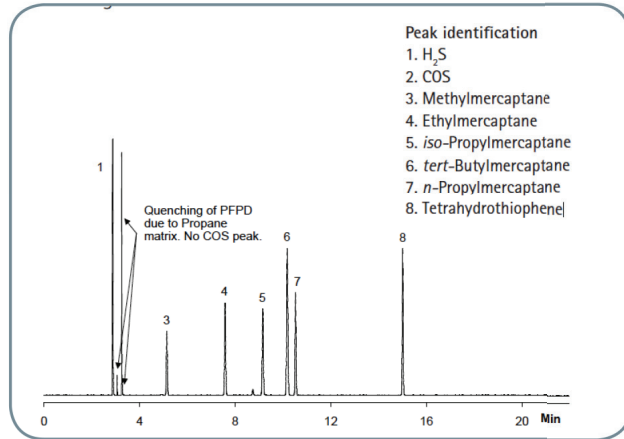

Figure 10a: Sulfur compounds in propane, BR-1 column

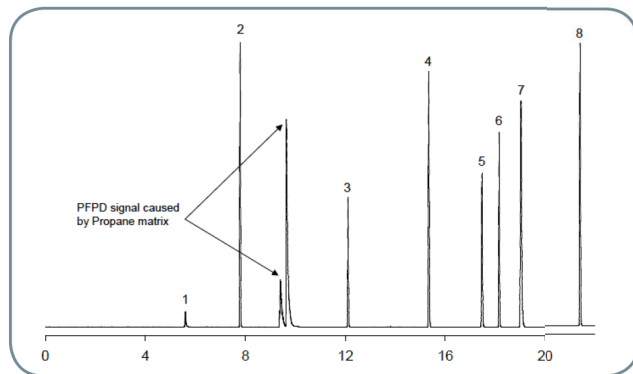

Figure 10b: Sulfur compounds in propane BR-QPLOT column

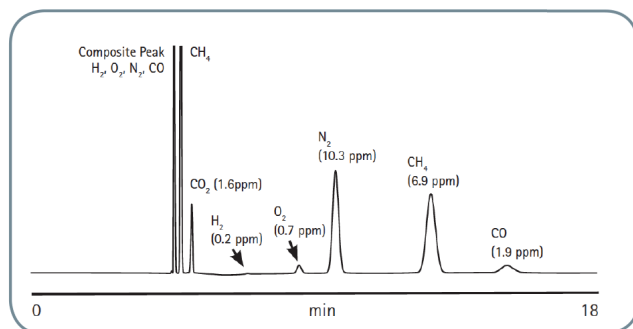

Figure 11: LPG Sample separation

# Total Characterization of Ethylene Impurities

For complete characterization of impurities in ethylene and also propylene, six GC channels are required. By coupling two Scion GCs with three channels each, a comprehensive solution is available for analyzing these components.

## GC-1

- H<sub>2</sub> Channel (TCD)
- O<sub>2</sub> / N<sub>2</sub> Channel (TCD)
- CO, CO<sub>2</sub> Channel (Methanizer/FID)

## GC-2

- Light Hydrocarbon Channel (FID)
- Oxygenates Channel (FID)
- Sulfur Channel (PFPD)

The results (see figures 12a-f) demonstrate how this 6 channel system is perfectly suited for the total characterization of ethylene and its impurities.

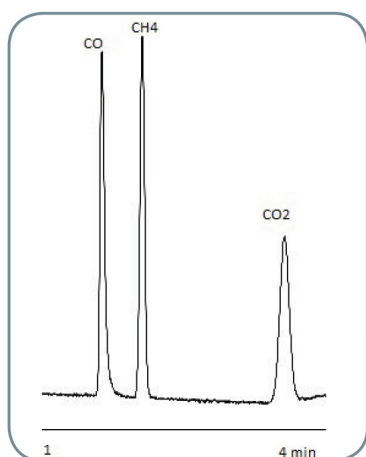

Figure 12a: CO, CH<sub>4</sub> and CO<sub>2</sub> on GC-1.

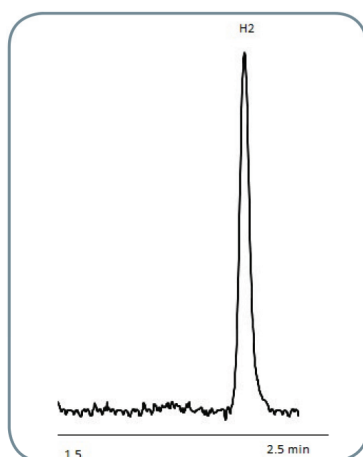

Figure 12b: H<sub>2</sub> on GC-1.

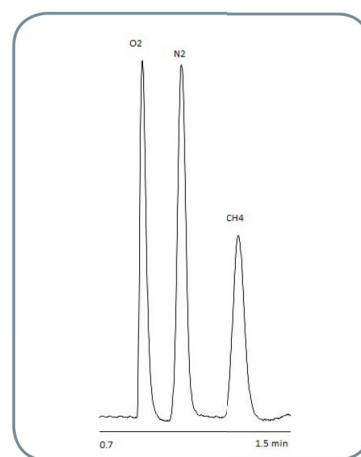

Figure 12c: O<sub>2</sub> and N<sub>2</sub> on GC-1.

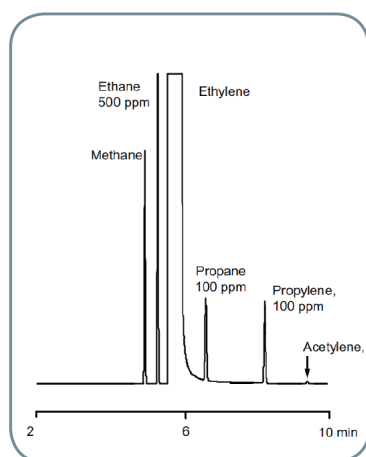

Figure 12d: Light hydrocarbons on GC-2.

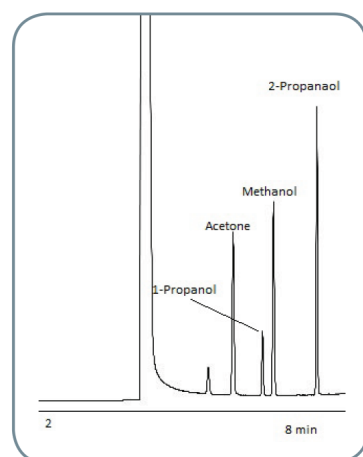

Figure 12e: Oxygenates on GC-2.

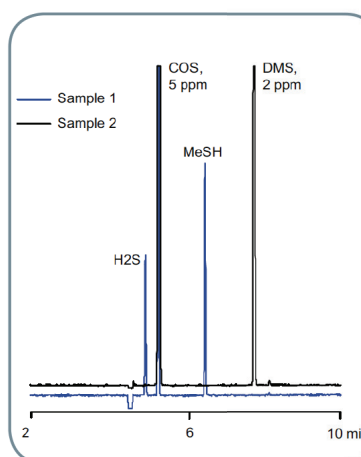
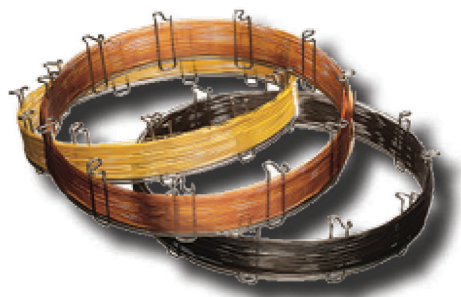

Figure 12f: Sulfur components on GC-2.

# Scion-Certified Consumables for Your SCION GC

Scion GC columns span a broad range of column lengths, diameters, stationary phases, and materials including: Fused Silica (FS) and Inert Steel (IS). Ideal for either routine or research type analyses, Scion GC columns cover a wide range of applications and include:

- Standard WCOT (Wall Coated Open Tubular)
- Solid Stationary Phase PLOT (Porous Layer Open Tubular)
- Inert Steel Micro-Packed and Packed



## Super Clean™ Gas Filters

Scion Gas Purification Systems have the range to satisfy your needs from individual to combination filters, from Ultra purity combined with Ultra capacity, to all in one solution kits. Innovative features designed into the product yield extensive benefits to the user.

- Ultra-high capacity for long life, less change and improved productivity
- High-purity output ensures 99.9999% Pure Gas
- "Quick connect" fittings for easy, leak-tight filter changes
- Glass internals prevent diffusion; plastic externally for safety
- Easy-to-read indicators for planned maintenance and improved up-time

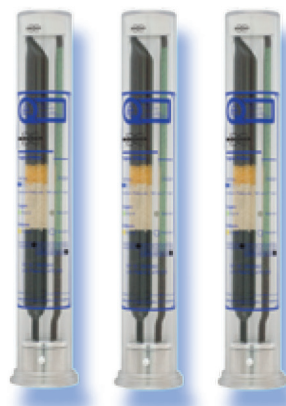

For research use only. Not for use in diagnostic procedures.



[www.ScionInstruments.com](http://www.ScionInstruments.com)

 **Instrument Solutions**  
*Technology for Your Success!*

**Authorised Distributor:**  
Instrument Solutions Benelux BV  
De Liesbosch 50 - 3439 LC Nieuwegein (NLD)  
Tel: +31(0)88 4678 786 / Fax: +31(0)88 4678799  
[www.instrument-solutions.com](http://www.instrument-solutions.com)  
[info@instrument-solutions.com](mailto:info@instrument-solutions.com)